

DX³ Shunt trip (ET)

Cat N°(s): 4 062 76, 78



CONTENTS	PAGE
1. Description - Use.....	1
2. Range	1
3. Overall dimensions.....	1
4. Preparation - Connection.....	1
5. General Characteristics	3
6. Compliance and approvals	3

1. DESCRIPTION - USE

- . Shunt release (ET): allows the remote tripping of the associated device and the remand of the signalling of the tripping by an integrated contact.
- . This device is equipped with a self-tripping contact

Symbol:

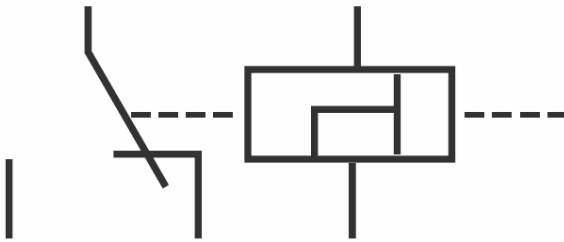

2. RANGE

- . Cat. n° 4 062 76: from 12 to 48 V~/= (a.c. / d.c.).
- . Cat. n° 4 062 78: from 110 to 415 V~ (a.c.) and from 110 to 125 V~ = (d.c.).

3. OVERALL DIMENSIONS

- . 1 module width

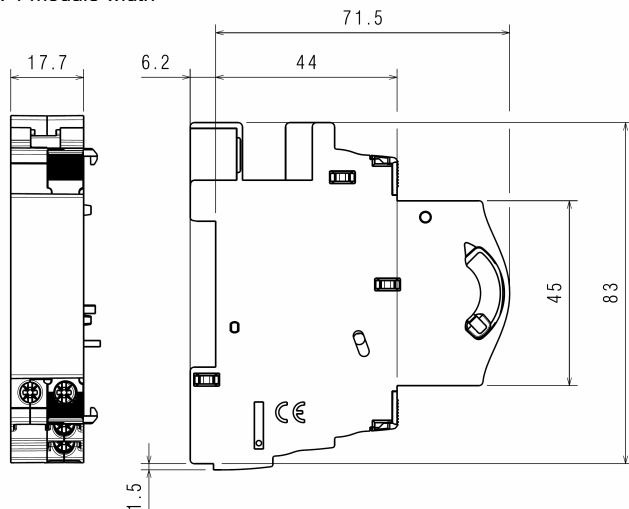

4. PREPARATION -CONNECTION

Fixing:

- . On symmetric EN/IEC 60715 or DIN 35 rail, by the device which is associated.

Operating positions:

- . Vertical Horizontal Upside down On the side

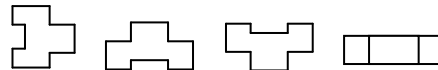

Power Supply:

- . Only from the bottom.

Terminals:

- . Terminal depth: 8 mm.
- . Stripping length: 8 mm

Screw head:

- . Mixed, slotted and Pozidriv n°1 (UNI7596 type Z1).

Recommended tightening torque:

- . 1 Nm.

Recommended tools:

- . For the terminals: Pozidriv n°1 or flat screwdriver 4 mm.

Conductor type:

	Copper cable	
	Without ferrule	With ferrule
Rigid Cable	1 x 0,5 mm ² to 1,5 mm ² 2 x 1,5 mm ²	-
Flexible Cable	1 x 0,5 mm ² to 1,5 mm ² 2 x 1,5 mm ²	1 x 0,5 mm ² to 1,5 mm ² 2 x 1,5 mm ²

Display of shunt release state:

- . By mechanical indicator on front face:
 - Red: indicates the tripping of the device by the coil. The auxiliary contact of the shunt release is in OFF position.
 - Transparent: the shunt release is in ON position (armed position, ready for tripping). The auxiliary contact of the shunt release is in ON position.

4. PREPARATION –CONNECTION (continued)

Manual actuation of the ET

. By the handle of the associated device, for reset the shunt release.

Assembling:

- . On the left side of Legrand MCB, IS, RCCBO, RCCB and isolating switches equipped or not with signalling auxiliaries
- . No tool required. Clipped by mean of plastic clamps on the associated device.
- . Assembling products in OFF position
- . The switching device of the shunt release must be positioned above of the handle of the associated device or the signalling auxiliary

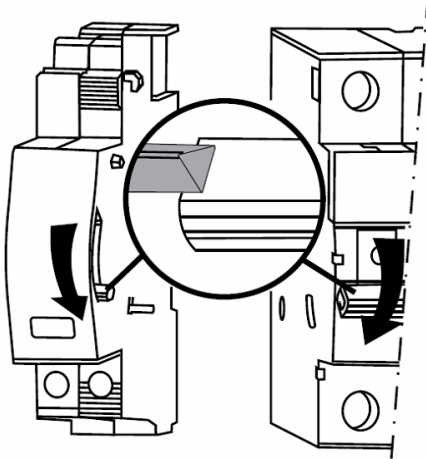

List of allowed associations (General rules):

Three auxiliaries maximum which:

- two signalling auxiliaries maximum. (Cat. n°(s) 4 062 58, 60, 62, 66).
- Only one control auxiliary (Cat. n°(s) 4 062 76, 78, 80, 82, 84).

. If signalling and control auxiliaries are associated on the same circuit breaker, the command auxiliary must be placed to the left of the signal auxiliary (ref. 4 062 5x / 6x).

List of allowed associations (Particular rules):

- . With an isolating switch DX-IS:
 - only one signalling auxiliary CA type (Cat. n°(s) 4 062 58 or 4 062 66).
- . With a remote trip head isolating switch DX-IS, three auxiliaries maximum which:
 - one or two signalling auxiliaries CA type (Cat. n°(s) 4 062 58 or 4 062 66).
 - one control auxiliary Cat. n°(s) 4062 7x / 8x.
- . With a MCB, IS, RCCBO, RCCB, three auxiliaries maximum which:
 - one or two signalling auxiliaries maximum, CA type or SD type (Cat. n°(s) 4 062 58, 60, 62, 66).
 - one control auxiliary cat n°(s) 4 062 7x / 8x.

4. PREPARATION –CONNECTION (continued)

Combinations of the auxiliaries:

		4062 .. 58 / 60 / 62 / 66 76 / 78 / 80 / 82 84 / 87	
	4062 .. 58 / 60 / 62 / 76 78 / 80 / 82 / 84 87	4062 .. 58 / 60 / 62	
	4062 .. 58 / 60 / 62 / 66 76 / 78 / 80 / 82 84 / 87	4062 66	
4062 .. 76/78/80 82/84/87	4062 .. 58 / 60 / 62	4062 .. 58 / 60 / 62	
	4062 .. 58 / 60 / 62 / 66	4062 66	

Wiring diagrams:

. Cat n 4 062 76.

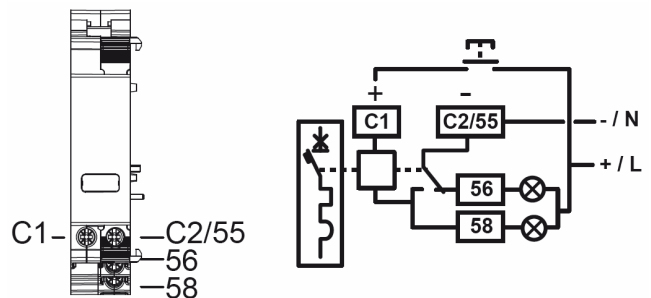

. Cat n 4 062 78

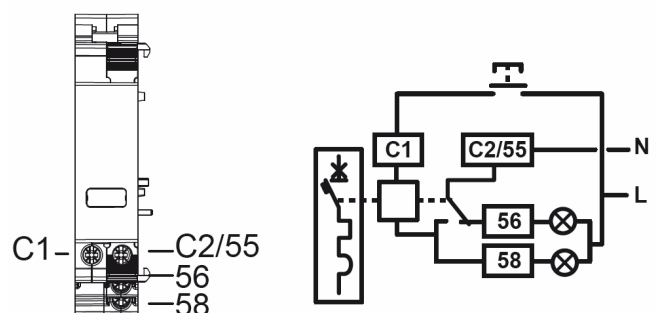

5. GENERAL CHARACTERISTICS

Front face marking:

. By permanent ink pad printing:

cat n° 4 062 76

cat n° 4 062 78

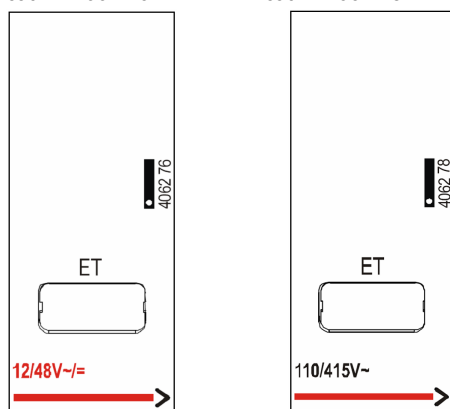

- Function name :
ET = voltage emission
- Operating voltage range
- Legrand reference code and Logo 

Operating voltage range (Un) :

. Cat. n° 4 062 76 : from 24 to 48 V ~/= (a.c. / d.c.).

. Cat. n° 4 062 78 : from 110 to 415 V~ (a.c.)
and from 110 to 125 V= (d.c.).

Operating range (in % of Un) :

. 70 to 115% of Un.

Tripping time:

. ≤ 20 ms.

Power absorbed:

. Cat. n° 4 062 76 :

- 12 V d.c. = 5,16 W.
- 12 V a.c. = 6,12 VA.
- 48 V d.c. = 56,45 W.
- 48 V a.c. = 94,56 VA.

. Cat. n° 4 062 78 :

- 110 V d.c. = 6,16 W.
- 110 V a.c. = 7,97 VA.
- 125 V d.c. = 7,62 W.
- 415 V a.c. = 120,76 VA.

Coil impedance:

. Cat. n° 4 062 76 : Z = 23 Ω.

. Cat. n° 4 062 78 : Z = 1640 Ω.

Thermal current:

. I_{the} = 6A.

Rated impulse withstand voltage:

. U_{imp} = 5kV.

Insulation voltage:

. U_i = 500 V

Dielectric strength:

. 2500 V.

5. GENERAL CHARACTERISTICS (continued)

Tripping force:

. 3 Nm.

Mechanical endurance:

. 3,000 electrical tripping.

. These devices support the mechanical cycles of the associated devices

Ambient temperatures:

. Operation: from - 25 °C to + 70 °C.

. Storage: from - 40 °C to + 70 °C.

Enclosure material:

. Polycarbonate charged 10% glass fiber.

. Characteristics of this material: self extinguishing, heat and fire resistant according to EN 60898-1, glow-wire test at 960°C for external parts made of insulating material necessary to retain in position current-carrying parts and parts of protective circuit (650°C for all other external parts made of insulating material).

Degree of class protection:

. Protection index of terminals against solid and liquid bodies: IP20 (in accordance with standards IEC 529, EN 60529 and NF C 20-010).

. Protection index of the box against solid and liquid bodies: IP40 (in accordance with standards IEC 529, EN 60529 and NF C 20-010).

. Protection index against mechanical shocks: IK02 (in accordance with standards EN 50102 and NF C 20-015).

Sinusoidal vibration resistance in accordance with IEC 60068-2-6.

. Axes : x, y, z.

. Frequency range: 5÷100 Hz ; duration 90 minutes

. Displacement (5÷13,2 Hz) : 1mm

. Acceleration (13,2÷100 Hz) : 0,7g (g=9,81 m/s²)

Average weight per device:

. 0,081 kg.

Volume when packed:

. 0,21 dm³.

6. COMPLIANCE AND APPROVALS

In accordance with:

. Standards IEC/EN 23-105, EN 60439-1 (Low Voltage Directive 2006/95/EC), EN 60439-3 (Directive EMC 2004/108/EC).

. CEE guidelines : 73/23/CEE + 93/68/CEE

Plastic materials :

. Halogens-free plastic materials.

. Marking of parts according to ISO 11469 and ISO 1043.

Packaging:

. Design and manufacture of packaging in accordance with Decree 98-638 of 07.20.98 and Directive 94/62/EC