

Stützpunktklemme, grün/gelb, Schraubanschluss, für Frontplattenbefestigung

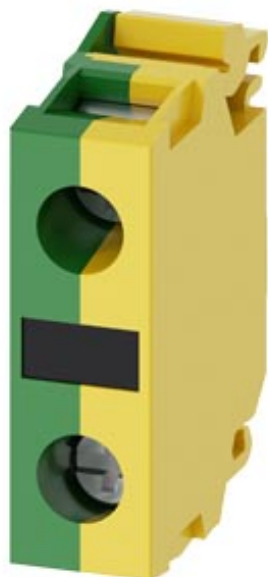

Produkt-Markename	SIRIUS ACT
Produkt-Bezeichnung	Stützpunktklemme
Produkttyp-Bezeichnung	3SU1

Allgemeine technische Daten

Eignung zur Integration	Ja
Verschmutzungsgrad	3
Stoßspannungsfestigkeit Bemessungswert	6 kV
Schutzart IP	
<ul style="list-style-type: none"> des Gehäuses der Anschlussklemme 	IP40 IP20
Referenzkennzeichen gemäß IEC 81346-2:2009	S
Referenzkennzeichen gemäß DIN EN 61346-2	S

Anschlüsse/ Klemmen

Ausführung des elektrischen Anschlusses	Schraubanschluss
<ul style="list-style-type: none"> der Module und Zubehör 	Schraubanschluss

Umgebungsbedingungen

Umgebungstemperatur	
<ul style="list-style-type: none"> während Betrieb 	-25 ... +70 °C

- während Lagerung





-40 ... +80 °C

Einbau/ Befestigung/ Abmessungen

Befestigungsart	Frontplattenbefestigung
• der Module und Zubehör	
Höhe	33,2 mm
Breite	9,8 mm
Tiefe	23,4 mm

Approbationen/ Zertifikate

allgemeine Produktzulassung	Konformitätserklärung	Prüfbescheinigungen	Marine / Schiffbau
 UL	 EAC	 EG-Konf.	 ABS
	Sonstige	Typprüfbescheinigung/Werkzeugnis	

Marine / Schiffbau	Sonstige
 LRS  PRS  RINA  RMRS	Bestätigungen

Weitere Informationen

Information- and Downloadcenter (Kataloge, Broschüren,...)

<https://www.siemens.de/ic10>

Industry Mall (Online-Bestellsystem)

<https://mall.industry.siemens.com/mall/de/de/Catalog/product?mfb=3SU1400-1DA43-1AA0>

CAX-Online-Generator

<http://support.automation.siemens.com/WW/CAXorder/default.aspx?lang=de&mfb=3SU1400-1DA43-1AA0>

Service&Support (Handbücher, Betriebsanleitungen, Zertifikate, Kennlinien, FAQs,...)

<https://support.industry.siemens.com/cs/ww/de/ps/3SU1400-1DA43-1AA0>

Bilddatenbank (Produktfotos, 2D-Maßzeichnungen, 3D-Modelle, Geräteschaltpläne, EPLAN Makros, ...)

http://www.automation.siemens.com/bilddb/cax_de.aspx?mfb=3SU1400-1DA43-1AA0&lang=de

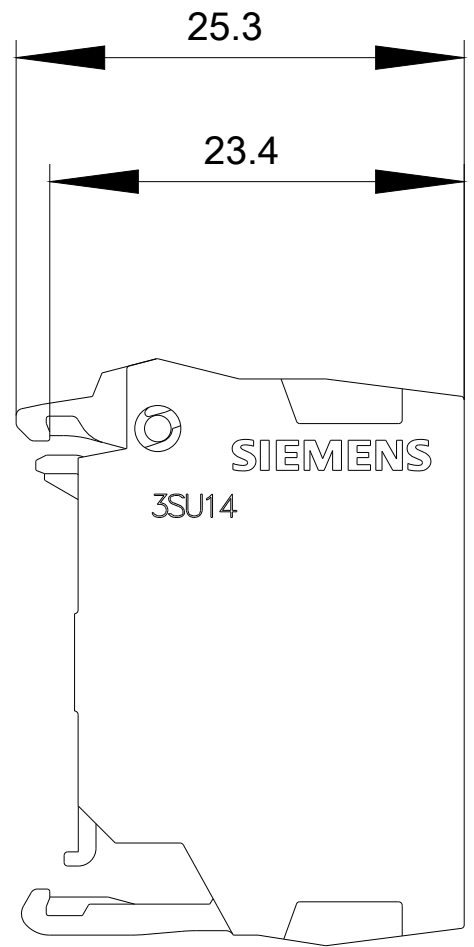
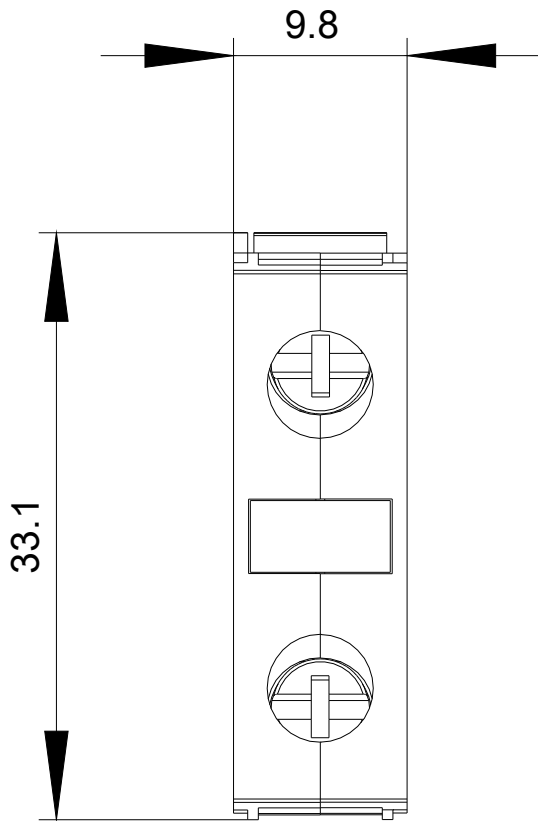

letzte Änderung:

19.05.2020