

Mosaic™ 10 AX switches

Cat. No(s): 0 770 00/01/02/10/11/12/14/21
 0 791 01/11/12 - 0 792 01/02/11/12/21

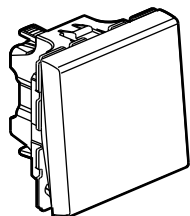

0 770 10/11 - 0 792 11

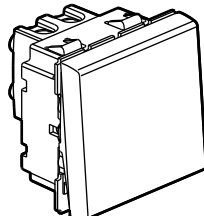

0 770 21 - 0 792 21

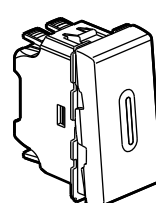

0 770 02 - 0 792 02

1. USE

General lighting control mechanisms with or without signalling components (indicator light).
 The mechanisms can be flush-mounted or surface-mounted.
 To be equipped with plate.

2. RANGE

	Description	White	Anthracite
	Switch - 1 module	0 770 00*	-
	Two-way switch - 1 module	0 770 01	0 791 01
	Two-way switch with LED indicator Equipped with a terminal for neutral connection - To be equipped with an indicator 1 module	0 770 02	-
	Switch - 2 modules	0 770 10*	-
	Two-way switch - 2 modules	0 770 11	0 791 11
	Two-way switch with LED indicator Equipped with a terminal for neutral connection - To be equipped with an indicator 2 modules	0 770 12	0 791 12
	Description	White	Aluminium
	Two-way switch - 1 module	-	0 792 01
	Two-way switch with LED indicator Equipped with a terminal for neutral connection - To be equipped with an indicator 1 module	-	0 792 02
	Two-way switch - 2 modules	-	0 792 11
	Two-way switch with LED indicator Equipped with a terminal for neutral connection - To be equipped with an indicator 2 modules	-	0 792 12

2. GAMME (suite)

	Description	White	Aluminium
	Two-way switch with a pull-cord Equipped with cord 1.5m - 2 modules	0 770 14	-
	Intermediate switch - 2 modules	0 770 21	-
	Intermediate switch - 2 modules	-	0 792 21

*Only 2 automatic terminals.

3. OVERALL DIMENSIONS (mm)

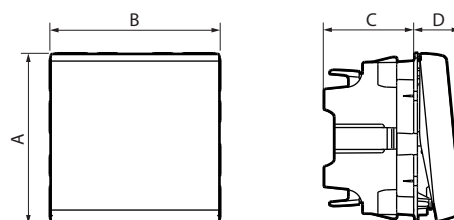

References	A	B	C	D
0 770 00/01/02 0 791 01 - 0 792 01/02	45	22.5	24	12.3
0 770 10/11/12 0 791 11/12 - 0 792 11/12	45	45	24	12.3
0 770 21 0 792 21	45	45	29.7	12
0 770 14	45	45	28.4	22

4. CONNECTION

References	Terminals	Capacity	Stripping	Screwdriver
0 770 21 0 792 21	With screws	2 x 2.5 mm ²	10 mm	Philips n° 1 Posidrive n° 1 Flat-blade 4 mm
0 770 00/01/02 0 770 10/11/12 0 791 01/11/12 0 792 01/02 0 792 11/12	automatic	2 x 2.5 mm ²	12 mm	-
0 770 14	automatic	2 x 2.5 mm ²	12 mm	-

5. WIRING

References: 0 770 02/12 - 0 792 02/12

Illuminated function: Illuminates the switch in the dark.

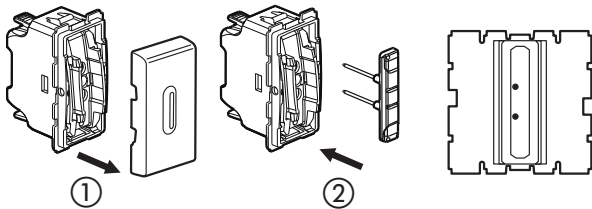

- 1 - Unclip the rocker
- 2 - Insert the indicator light Cat. No. 0 676 86 or Cat. No. 0 676 87

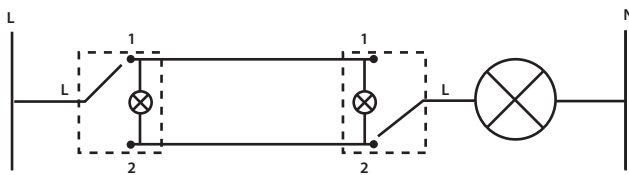
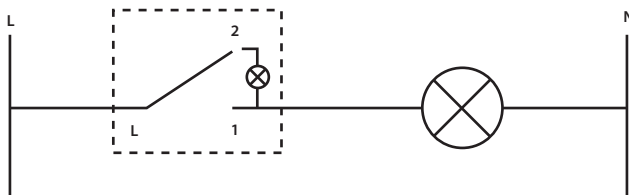

5. WIRING (continued)

Indicator function: The lamp is switched on when the lighting is on.

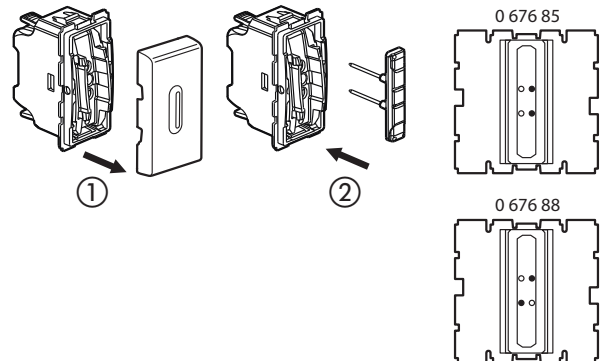

- 1 - Unclip the rocker
- 2 - Insert the indicator light Cat. No. 0 676 88 or 0 676 85

Switch

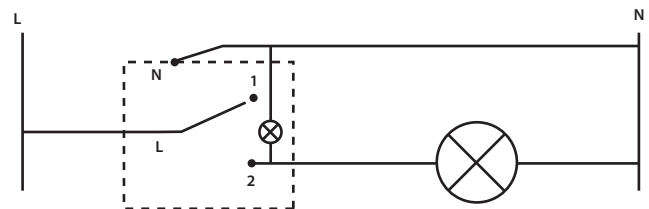

Two-way switch existing cabling, indicator light 0 676 85

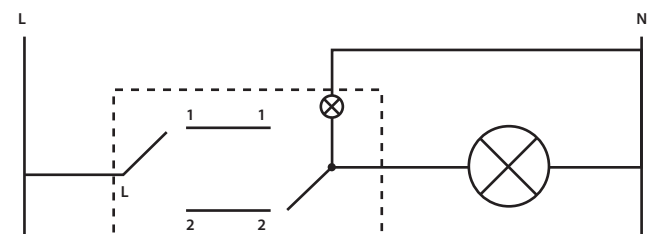

Two-way switch, indicator light 0 676 88

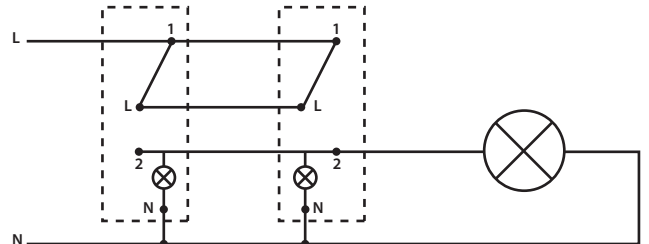

Note: Do not mix old motor (manufacture before July 2014) with new motor (manufacture after July 2014).

6. TECHNICAL CHARACTERISTICS

■ 6.1 Mechanical characteristics

Impact tests: IK 04

Protection against solid bodies and liquids: IP 31 D

■ 6.2 Material characteristics

- Rocker: ABS

- Base: PC

- Rocker support: PC

- Halogen free

- UV resistant

Self-extinguishing:

+ 850°C / 30 s for insulating components holding in place live parts.

+ 650°C / 30 s for the other insulating components.

■ 6.3 Electrical characteristics

Voltage: 250 VAC

Current: 10 AX expect Cat. No. 0 770 14: 6 AX

■ 6.4 Climatic characteristics

Storage temperature: - 10° C to + 70° C

Operating temperature: - 5° C to + 35° C

7. CLEANING

Surface cleaning with a cloth.

Do not use: acetone, tar remover, trichloroethylene.

■ 7.1 Resistance to cleaning agents

Resistance to the following agents: Hexane (EN 60669-1), methylated spirits, soapy water, diluted ammonia, pure bleach diluted 10%, glass cleaning substance, pre-impregnated wipe.

■ 7.2 Resistance to hospital-type cleaning agents

Resistance to the following agents: Anios, Surfaniol, Bactylisine, Diluted hydrogen peroxide (35%).

Caution: A preliminary test should be carried out if other specific cleaning products are to be used.

8. ACCESSORIES

Lights for switches with indicator light:

Switches	Illuminated	Indicator
0 770 02		
0 770 12	0 676 86 (230 V / 0.15 mA)	0 676 85 (230 V / 3 mA)
0 792 02	0 676 87 (12/24/48 V)	0 676 88 distributed phase (230 V / 3 mA)
0 792 12		

9. CONFORMITY AND APPROVALS

Compliance with standards of installation and manufacturing.

See e.catalogue.