

ARTIKEL 104833 ZXE-104833

Beschreibung	Technische Daten	Zubehör	Downloads
--------------	------------------	---------	-----------



Merkmale

- › 3-stufige Funktion
- › Zweikanalige Ausführung
- › 22,5 mm Einbaumaß
- › Sprungschaltglied
- › Mit Klick
- › Schraubklemmen

Hinweise

- › Zustimmtaster ZXE-104833 für Verwendung in Gehäuse HBA/HBM
- › Beim Wechsel von Stufe 1 in Stufe 2 und bei der Rückführung von Stufe 2 in Stufe 1 ertönt ein Klicken.

Schaltelement

2202 2S/Ö

- 1) Von Position 1 nach Position 2 -> Schließer; Von Position 2 nach Position 3 -> Öffner.

3-stufige Funktion

Zustimmfunktion nur in der zweiten Stufe (Mittelposition, Druckpunkt) aktiv.

Verschmutzungsgrad (extern, nach EN 60947-1)	3
Anschlussleitung	
AWG	16 ... 22
eindrchtig, in mm	0,3 ... 1,4
Anschlussquerschnitt	
eindrchtig	1,5 mm ²
feinstdrchtig	1 mm ²
Anschlussquerschnitt AWG	16 AWG
Schaltleistung	max. 0,25 W

Sonstiges

Zustzliches Merkmal	Klick
erfllte Normen	DIN EN 60947-5-8
Farbe	
Gehuse	schwarz
Schutzkappe	schwarz

Zuverlssigkeitswerte nach EN ISO 13849-1

B10 _d	0,75 x 10 ⁶
------------------	------------------------

[1] von Stufe 2 nach 3

Maßzeichnung

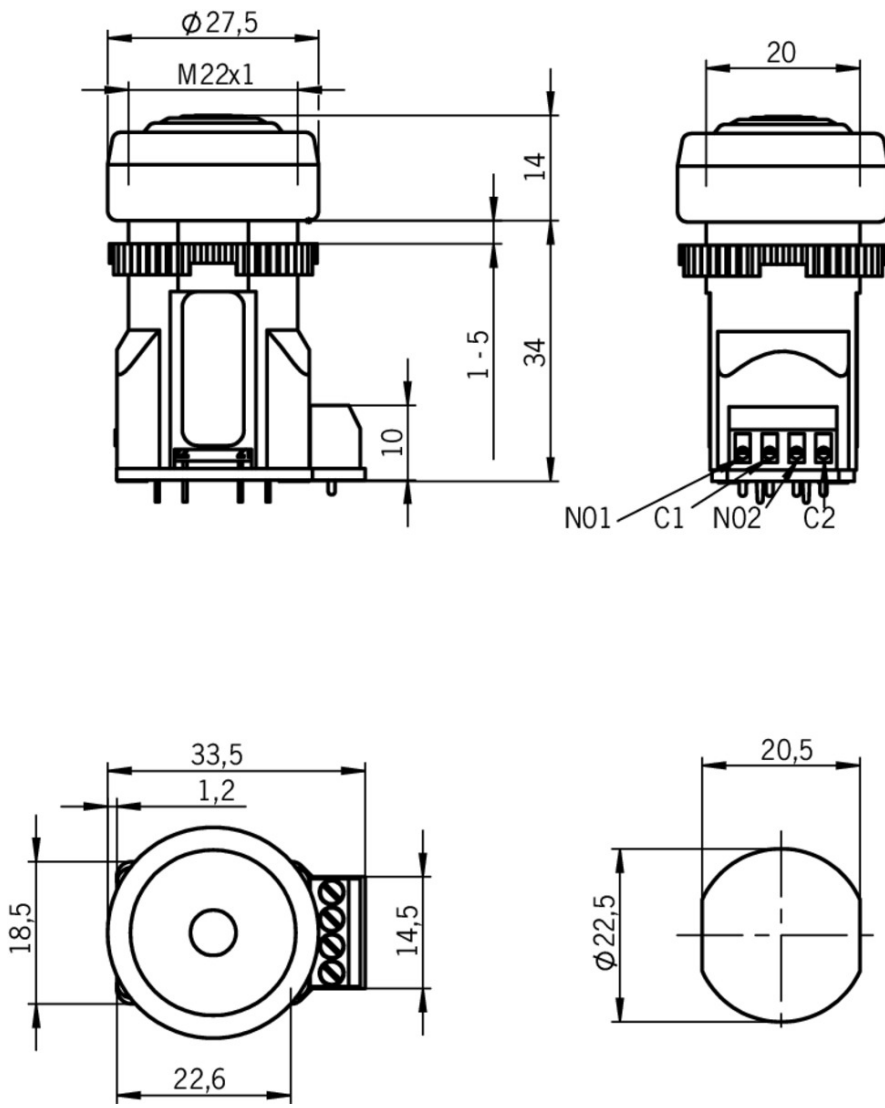

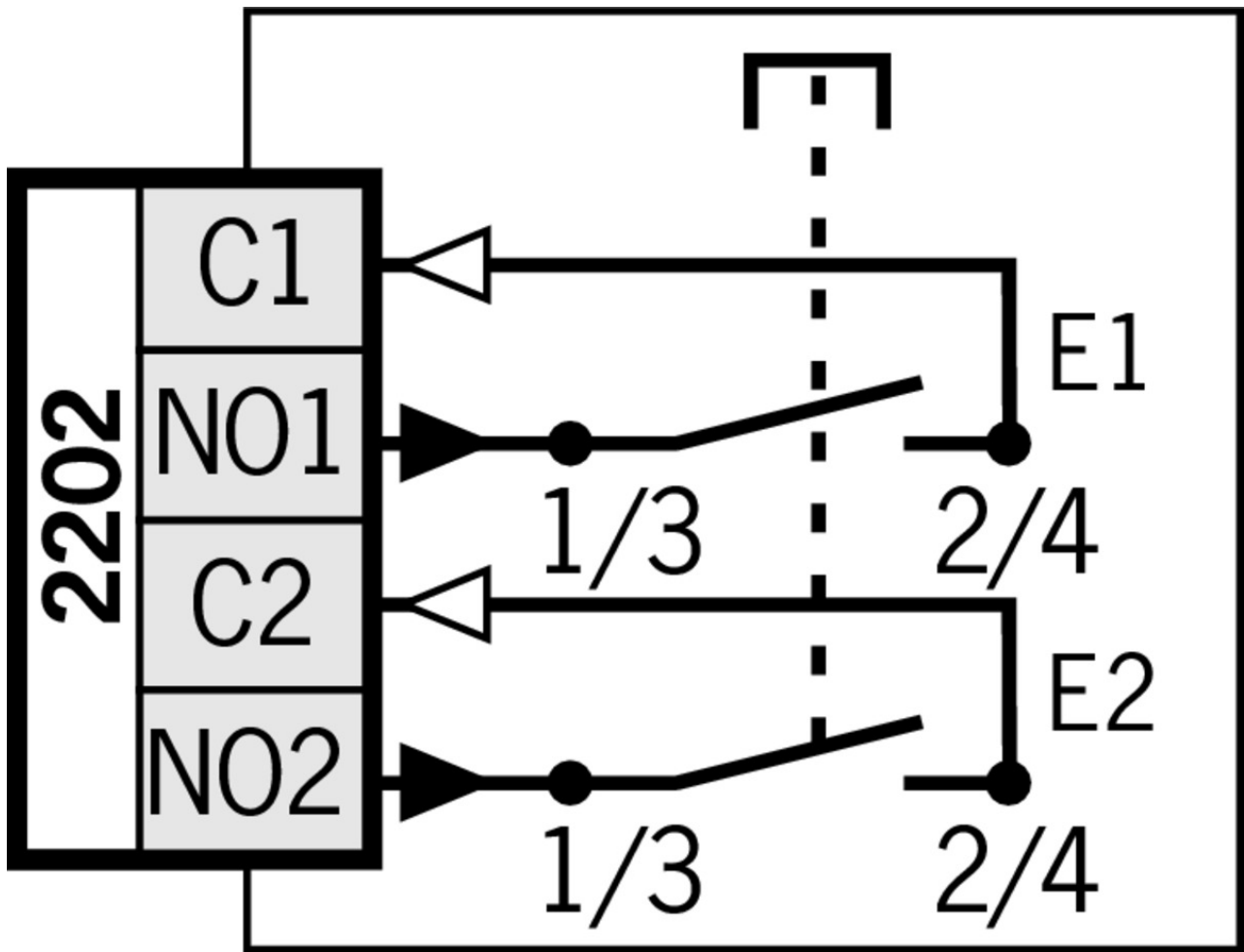

Schaltwegdiagramm

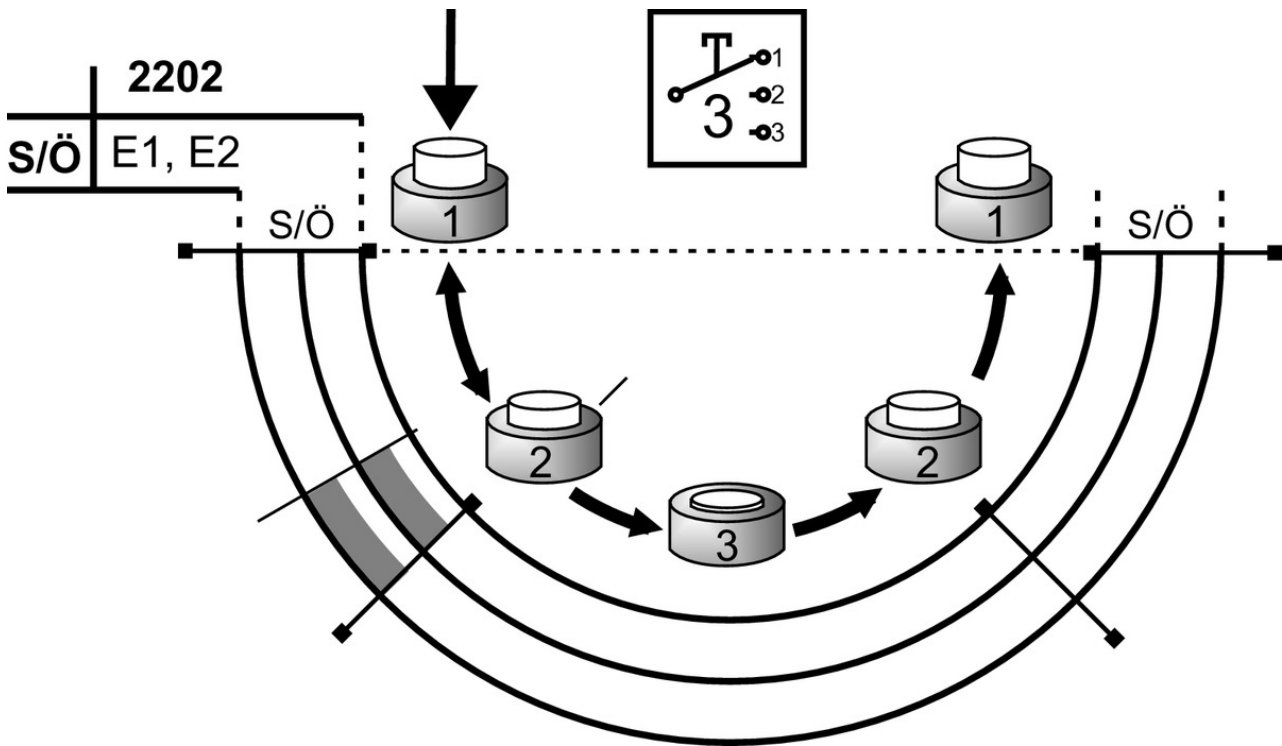

Legende

- offen
- geschlossen
- geschlossen, Zustimmung





Anleitungen

- Betriebsanleitung Zustimmtaster ZXE







	Dok.-Nr.	Version	Sprache	Download
Betriebsanleitung Zustimmtaster ZXE Operating Instructions Enabling Switch ZXE Manual de instrucciones del pulsador de validación ZXE Mode d'emploi de la commande d'assentiment ZXE Istruzioni di impiego del pulsante di consenso ZXE	091418	05-12/13	    	 0.7 MB
Инструкция по эксплуатации выключателя подтверждения ZXE	091418	05-12/13		 0.4 MB

Kataloge

▼ Zustimmungster ZS





	Dok.-Nr.	Version	Sprache	Download
Zustimmungster ZS	095689	07-11/12		 14.5 MB
Enabling switches ZS	095690	07-11/12		 14.4 MB
Commandes d'Assentiment ZS	097367	07-11/12		 14.8 MB

▼ Handbediengeräte/Handräder

	Dok.-Nr.	Version	Sprache	Download
Handbediengeräte/Handräder	098619	07-05/13		 8.7 MB
Hand-Held Pendant Stations/Handwheels	099443	07-05/13		 8.6 MB
Pupitres portables/Manivelles	111529	07-05/13		 8.7 MB

Konformitätserklärung

▼ EG-Konformitätserklärung ZSA; ZSB; ZSE; ZSM; ZSR; ZSG; ZX; ZS...-AS

	Dok.-Nr.	Version	Sprache	Download
EG-Konformitätserklärung ZSA; ZSB; ZSE; ZSM; ZSR; ZSG; ZX; ZS...-AS EC-Declaration of Confomity ZSA; ZSB; ZSE; ZSM; ZSR; ZSG; ZX; ZS...-AS CE-Declaración de Conformidad ZSA; ZSB; ZSE; ZSM; ZSR; ZSG; ZX; ZS...-AS CE-Déclaration de Conformité ZSA; ZSB; ZSE; ZSM; ZSR; ZSG; ZX; ZS...-AS CE-Dichiarazione di conformità ZSA; ZSB; ZSE; ZSM; ZSR; ZSG; ZX; ZS...-AS	109392	03-02/16	    	 0.8 MB

CAD-Daten

CAD Daten für diesen Artikel auf TraceParts